

Distributed By: PipeMan Products, Inc.  
TF: 1-877-747-3626

## **KWIK SNAP** **Model 2500**

---

### **Cast Iron Pipe Cutting Machine**

Congratulations on your purchase of the Kwik Snap 2500. With proper use, this machine should afford you years of service while saving you money. Please familiarize yourself with the information in this manual before using your Kwik Snap 2500 Cast Iron Pipe Cutting Machine.

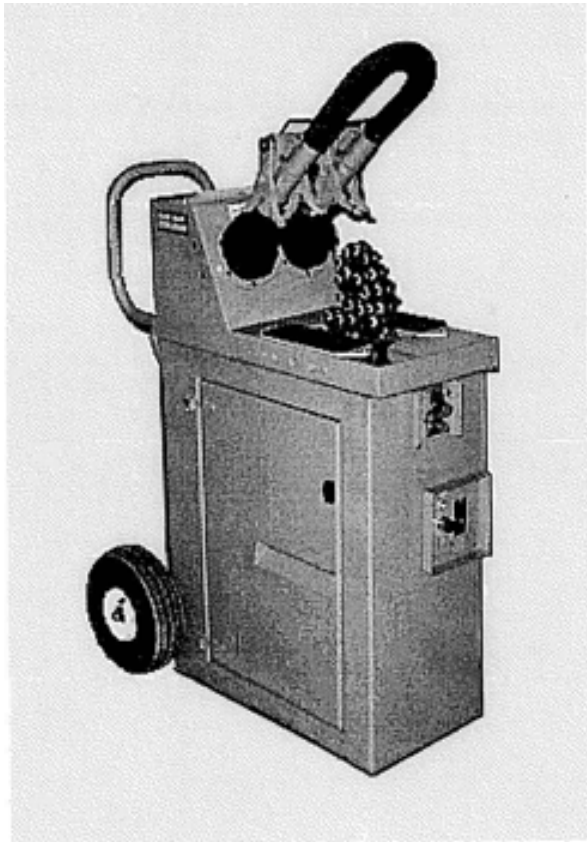

# Operator Safety Instructions

Although Kwik Snap 2500 is manufactured for safe, dependable operation, it is impossible to anticipate of all those combinations of circumstances which could result in an accident. The operator is cautioned to always practice "Safety First" during each phase of use, including setup and maintenance of this unit. The following instructions are recommended for safe operation of the machine.

Before operating or performing maintenance of this machine, read this operator's manual carefully. Become familiar with the machine's operation, applications and limitations. Be particularly aware of its specific hazards. Store the operator's manual in a readily available location and maintain it in legible condition. Additional copies are available upon request to manufacturer or at:

[http://www.harrison-isi.com/downloads/hisi\\_kwiksnap2500manual.pdf](http://www.harrison-isi.com/downloads/hisi_kwiksnap2500manual.pdf)

Prior to attaching the Kwik Snap 2500 to an electrical power source, check the movable parts for obstructions such as rags, packing remnants, etc. Be certain that machine parts are properly installed and secured.

Flip the motor control switch on front panel to the "OFF" position before plugging the machine in. Make sure the cutting chain is free from entanglements with other hardware, i.e. do not allow the cutting chain to be hooked or bound in any way that would prohibit free movement. When the machine is plugged into a power source, the red indicator light on the front panel should be illuminated. At this point, flip the motor control switch to the "ON" position. If the hydraulic cylinder is at the proper reset position, nothing should happen, i.e. the hydraulic pump motor should not run and the cutting chain should not move. If the hydraulic cylinder has retracted slightly from its reset position (as might occur during transit or after a long period of storage), the hydraulic pump motor will run long enough to allow the machine to reset. Once reset, the hydraulic pump motor will shut off. (When the unit is plugged in, it is important to allow the cylinder to go to its reset position, otherwise the valve that operates the reset function will overheat.) In the event that the hydraulic pump motor is running and the cutting chain is being pulled into the mechanism (as would be the case when the cutting chain is being tightened around the circumference of a pipe), verify that the overarm (actuating arm) is in its relaxed and retracted position (not in the actuating position).

## Safety First

## Read & Understand the Instruction Manual

## Inspect the Equipment

## Prevent Accidental Starts

## **Operator Safety Instructions (continued)**

Proper grounding of the machine is essential to eliminate the hazard of electrical shock to the operator. The machine is equipped with an approved three-prong plug for use with a properly grounded three-prong electrical cord and power source.

### **Ground the Machine**

Keep the work area adjacent to the machine clear of clutter to afford the operator unobstructed movement. Contain any small pieces of pipe in a suitable container to prevent possible trip hazards.

### **Keep Work Area Clean**

A minimum of safety glasses, a long sleeve shirt with buttoned sleeves and gloves should be worn by the operator to afford some protection from possible flying pipe fragments.

### **Wear Proper Clothing**

Keep balance and proper footing at all times. Always operate machine from directly in front of machine.

### **Operate from Proper Position**

Keep machine clean for safe, dependable operation. Inspect cutting chain regularly for worn or non-rotatable cutting wheels. Excessively worked chains should be replaced prior to continued use of the machine. Keep chain lubricated and clean. Report any unsafe condition to your supervisor for immediate correction before using machine. Always keep machine out of reach of children.

### **Always Maintain Machine**

Do not operate machine if ill or drowsy from medication or fatigue. Pipe will often separate with considerable force at a right angle to the chain. Be sure that when putting cutting pressure on a pipe, there are no other personnel in the immediate area. (Do not stand at the end of the pipe while cutting. Do not lift machine by actuating handle.)

### **Keep Alert**

Machine should not be operated in damp locations or exposed to rain. Insure proper illumination in work area.

### **Operate in Proper Environment**

Use the machine only for functions for which it is designed. Do not attempt to modify the machine to perform any other functions. Such misuse will void any warranty and may cause severe physical harm to persons or equipment.

### **Do Not Misuse Machine**

## **Operator Safety Instructions (continued)**

Repair should be attempted only by authorized personnel. Always disconnect power cord before making any adjustments or servicing the machine. Do not jerk the power cord from the electrical receptacle to disconnect the unit.

All visitors and bystanders should be kept a safe distance from work area.

The wheels are for hand trucking only.

Pipe often will separate with considerable force at a right angle to the cutting chain. Be sure when putting cutting pressure on pipe, that you are standing in front of the machine facing the cutter or pipe and that there are no other personnel in the immediate area. (Do not stand at the end of the pipe while cutting. Do not lift machine by the actuating handle.)

Carefully review the General Parts Identification section in this manual to familiarize yourself with the machine.

**Disconnect Power  
Cord Prior to  
Servicing**

**Keep Visitors Away**

**Never Attempt to Tow  
Your Machine**

**Comply With All  
O.S.H.A. Safety  
Regulations When  
Operating the Kwik  
Snap Machine**

**Know Your Machine**

## KWIK SNAP 2500 Basic Parts Identification

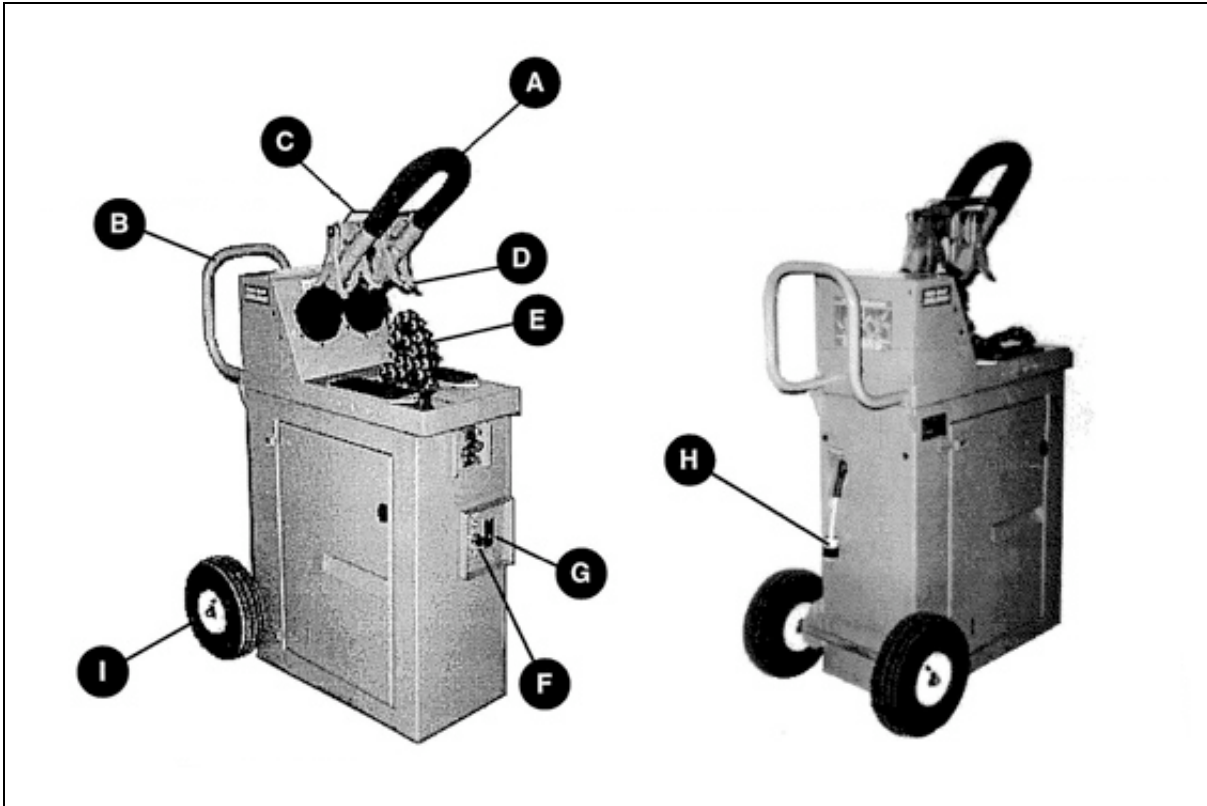

DESCRIPTION	REF.	PART NO.
Actuating Arm (Overarm Subassembly, Handle Tube)	A	3322-OA-51.0
Hand Trucking Handle (Top Plate Subassembly, Handle)	B	3322-TP-23.0
Safety Shield	C	3322-OA-1.5
Hold Down "Veas"	D	3322-OA-38.0
Cutting Chain Assembly	E	3322-SM-14.5
Power Indicator Lamp	F	3322-EB-6.5
Motor Control Switch	G	3322-EB-7.5
115 Volt Power Cord	H	3322-PI-1.5
Wheel & Tire Assembly	I	3322-CB-19.5

## KWIK SNAP 2500 Basic Parts Identification (continued)

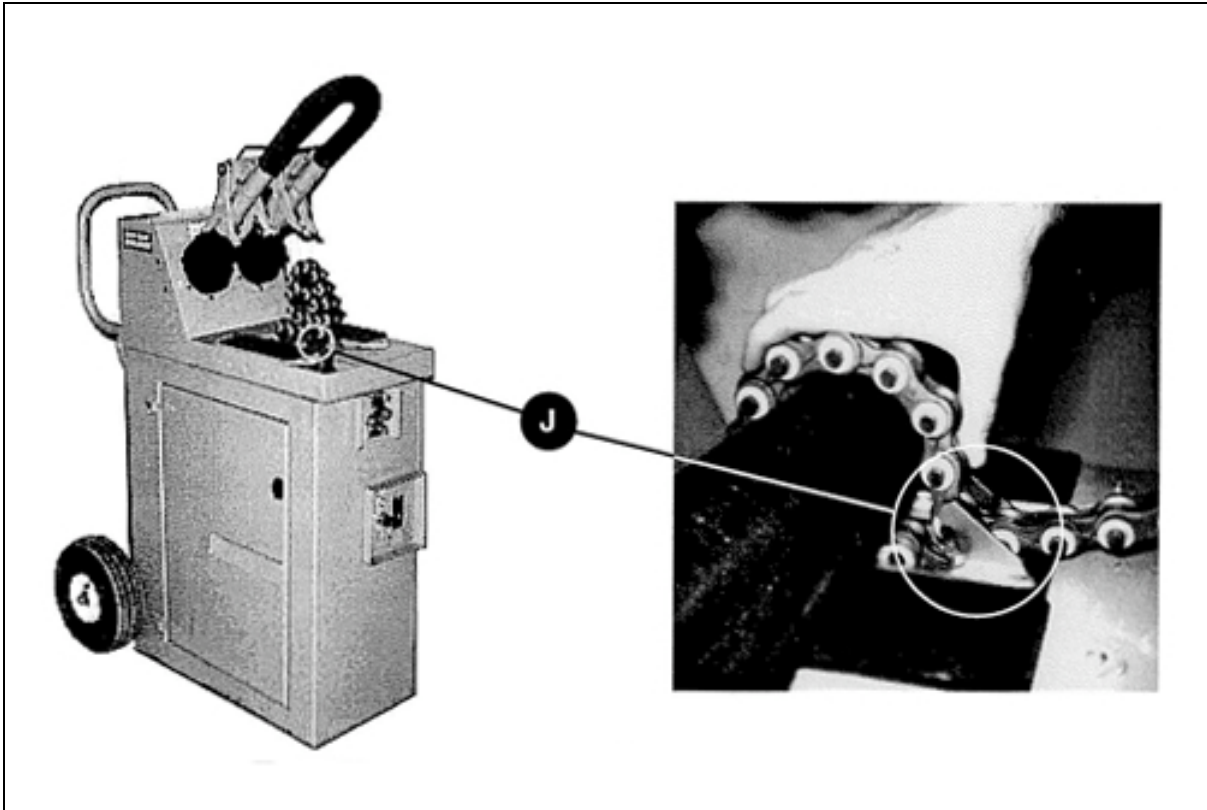

DESCRIPTION	REF.	PART NO.
Chain Cleat Assembly	J	3322-SM-1.5

## KWIK SNAP 2500 Basic Parts Identification (continued)

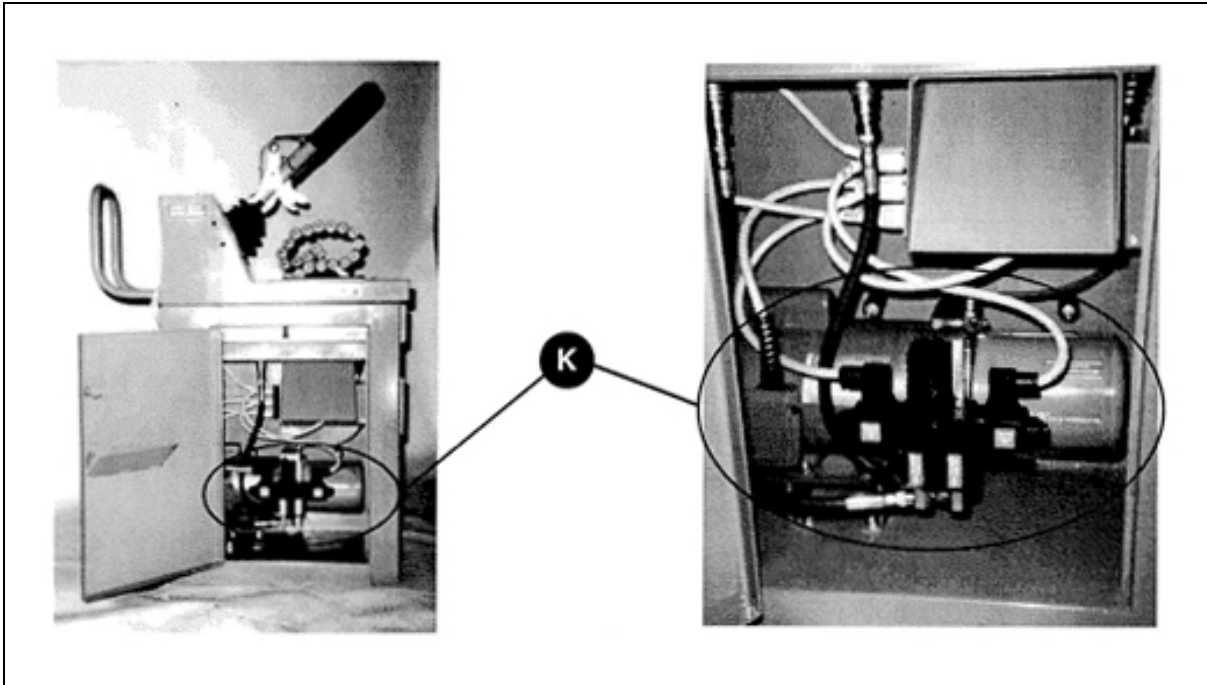

DESCRIPTION	REF.	PART NO.
Hydraulic Pump Motor (Hydraulic Power Unit Subassembly)	K	3322-HP-8.5

## KWIK SNAP 2500 Basic Parts Identification (continued)

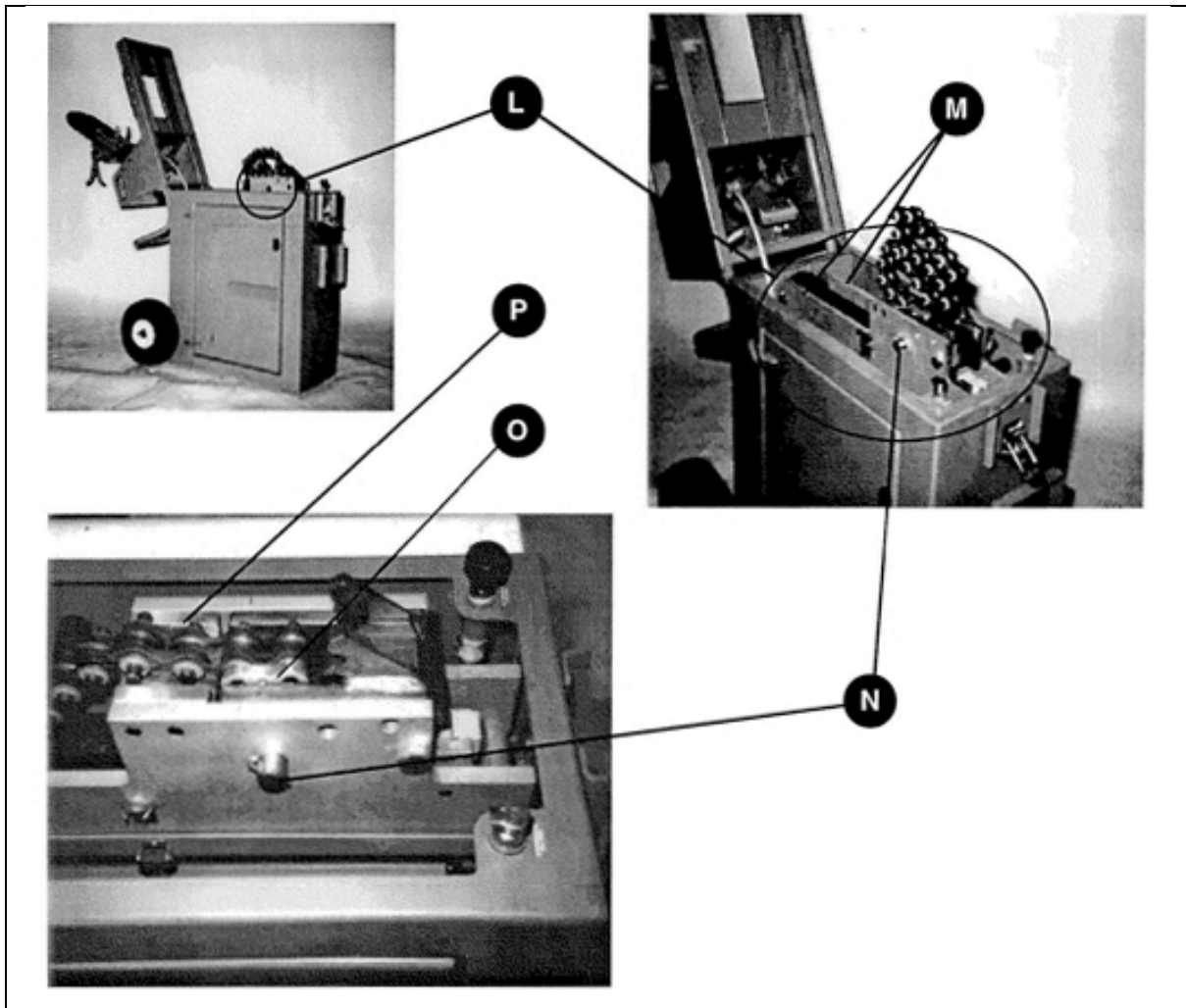

DESCRIPTION	REF.	PART NO.
Snapping Mechanism Assembly	L	3322-SM-3.5
Snapping Mechanism Side Plates (Left & Right)	M	3322-SM-3.0 L/R
Cam Pivot Pin	N	3322-SM-9.0
Anti-knuckle Device	O	3322-SM-24.0
Chain Ski	P	3322-SM4.0



## KWIK SNAP 2500 Specifications

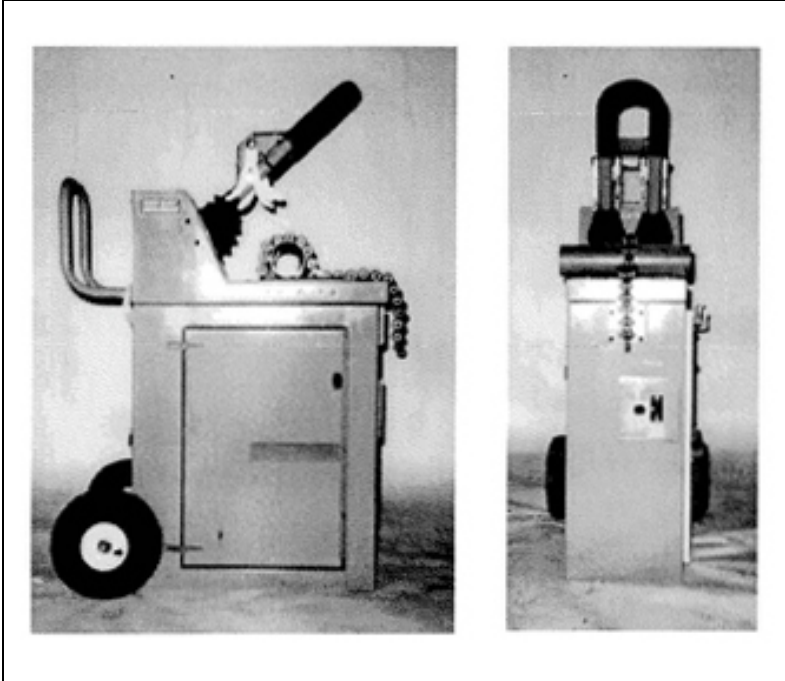

Kwik Snap 2500 is shown here with short section of pipe for clarity.

The Kwik Snap 2500 is designed to cut:  
Hubless Cast Iron Pipe: \_\_\_\_\_ 1-1/2" through 6" Nominal Dia.  
Vitreous Clay Pipe: \_\_\_\_\_ 4" Nominal Diameter  
Not suitable for cutting ductile iron.  
Check other applications with manufacturer.

Length: 32"                      Width: 20"                      Height: 50"

Machine Proper (less oil): \_\_\_\_\_ 270 lbs.  
48" Table: \_\_\_\_\_ 15 lbs.  
72" Table: \_\_\_\_\_ 20 lbs.  
Table Rack (1 required per table): \_\_\_\_\_ 5 lbs.

Motor: \_\_\_\_\_ 1 H.P., 11.2 Amps, 60 Hz, 115 Volts, 3450 RPM  
Insulation: \_\_\_\_\_ Class B  
**Warning: All machines are wired to operate on 115V only.**

Reservoir Capacity: \_\_\_\_\_ Approximately 3 quarts  
Fluid Type: \_\_\_\_\_ 20 wt, Mobil DTE 26

### Capacity

### Dimensions

### Weight

### Motor/Pump

### Hydraulic System

## Preparing for Operation

Operator should be thoroughly familiar with preceding SAFETY INSTRUCTIONS before attempting to operate this equipment.

### NOTICE

Flip motor control switch on front panel to the "OFF" position before plugging the machine in. Make sure the cutting chain is free from entanglements with other hardware, i.e. do not allow the cutting chain to be hooked or bound in any way that would prohibit free movement. When the machine is plugged into a power source, the red indicator light on the front panel should be illuminated. At this point, flip the motor control switch to the "ON" position. If the hydraulic cylinder is at the proper reset position, nothing should happen, i.e. the hydraulic pump motor should not run and the cutting chain should not move. If the hydraulic cylinder has retracted slightly from its reset position (as might occur during transit or after a long period of storage), the hydraulic pump motor will run long enough to allow the machine to reset. Once reset, the hydraulic pump motor will shut off. (When the unit is plugged in, it is important to allow the cylinder to go to its reset position, otherwise the valve that operates the reset function will overheat.) In the event that the hydraulic pump motor is running and the cutting chain is being pulled into the mechanism (as would be the case when the cutting chain is being tightened around the circumference of a pipe), verify that the overarm (actuating arm) is in its relaxed and retracted position (not in the actuating position).

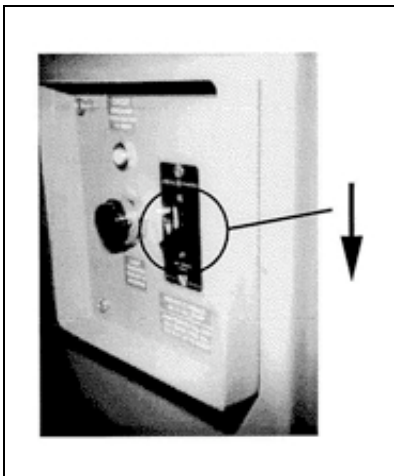

Make sure motor control switch is in "OFF" position.

NOTE: The motor control switch does not turn the motor on and off. It functions as a circuit breaker.

### Motor Control Switch in "OFF" Position

## Preparing for Operation (continued)

### Inspect Cutter Wheels

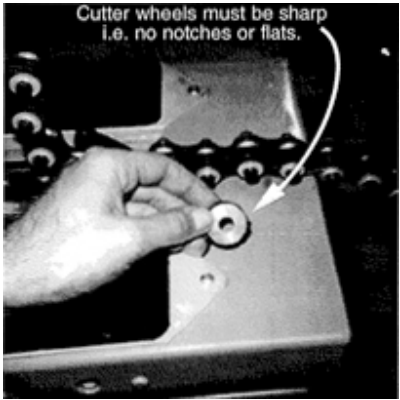

With motor control switch in "OFF" position, inspect chain cutter wheels for excessive wear or inability to spin or rotate on pins. Replace or reverse worn cutting chain. Cutting chain life can often be effectively doubled by reversing the chain as most wear will occur on cutter wheels nearest the position where cutting chain attaches to the hydraulic tensioner. (See cutting chain replacement instruction section.)

### Connect Machine to Power Source



Connect the machine only to grounded, 115 volt, 60 Hz, single phase power source.

### Motor Control Switch in "ON" Position

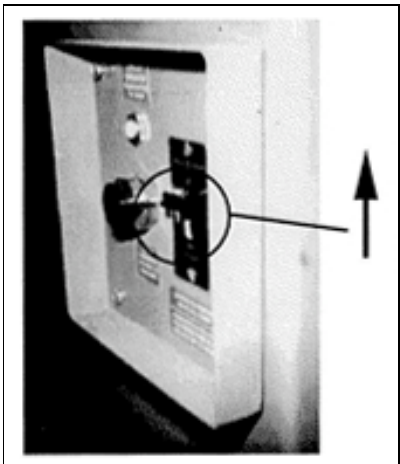

Prior to position pipe for cutting, turn motor control switch to "ON" position. Observe that NO movement of chain tensioner occurs. Should movement occur, shut off machine and disconnect power until problem is diagnosed and remedied. (Consult Trouble Shooting Guide.)

## Cutting Pipe



With actuating arm (overarm) in fully upright position, pull cutting chain toward rear of machine. Position pipe across chain snapping mechanism, with cutting chain behind pipe.

If not using the optional tables with the machine, make sure that the pipe is supported level with the top of the machine. Do not try to cut pipe that is not supported at both ends.



Wrap cutting chain around pipe and secure pin of appropriate link in chain cleat. In order to hook link pin in the cleat, it will be necessary to overcome the force of the spring in the cutting chain. Before depressing actuating arm, align pipe and cutting chain by visually checking to assure that cutting chain is uniformly square in relation to pipe. Likewise, make certain that pipe is at a 90° angle to cutting chain in order to achieve a square cut.

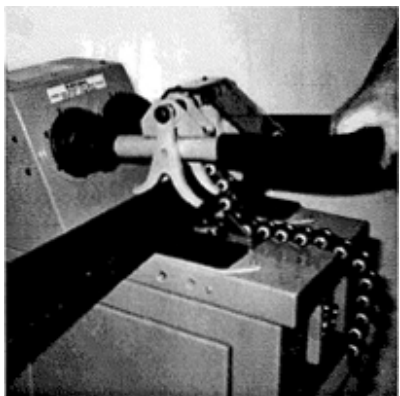

Depress actuating arm until "hold-down vees" hold pipe firmly against rubber anti-projection pads and actuating arm "bends" or hinges at pivot point. This bending actuates switch causing cutting chain to tighten around pipe until pipe is severed.

### Position Pipe on Machine

### Secure Cutting Chain Around Pipe

### Depress Actuating Arm

## Cutting Pipe (continued)

### Raise Actuating Arm



Immediately upon snapping (severing) the pipe, raise the actuating arm. This reverses the cutting chain tightening cycle.

The pipe should be cut almost instantly upon cutting chain being tensioned. If it does not, consult the Trouble Shooting Guide.

### NOTICE

Dull, flat, excessively worn cutter chains must be replaced or repaired prior to use. Continued use of a dull cutting chain will place undue strain on virtually all mechanical parts and will therefore void warranty.

### CAUTION

## Replacing the Cutting Chain

The first step in any maintenance or repair procedure

### De-energize Machine

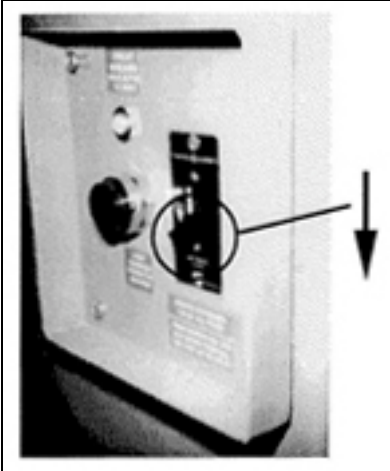

1. Turn the motor control switch to the "OFF" position.



2. Disconnect the power cord.

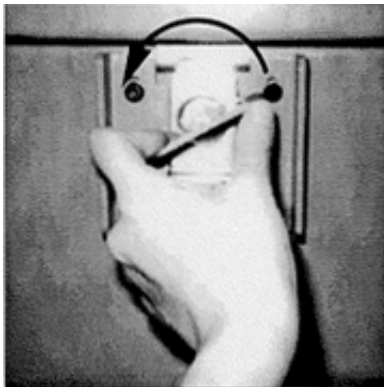

1. Twist the Cam Latch at the front of the machine counter-clockwise to unlatch.

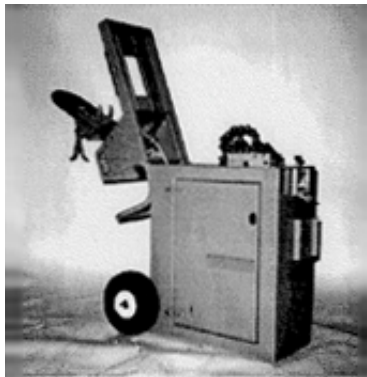

2. Lift the Top Plate.

### Open Top Plate

## Replacing the Cutting Chain (Continued)

### Remove the Cam Pivot Pin

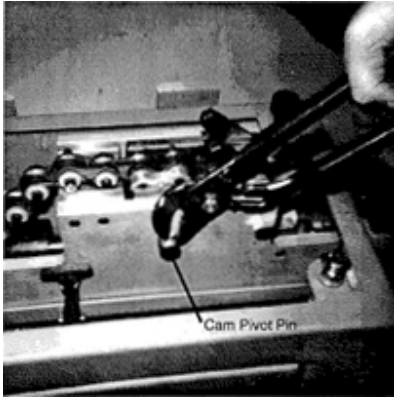

Remove cotter pin from cam pivot pin.

Using a rod (approximately 1/4" in diameter and about 8" long, for example a Phillips screwdriver), push out the cam pivot pin.



Using an 3/16" allen wrench, remove the socket head cap screws which hold the chain ski in place (two socket head cap screws on each side of the chain ski).

### Remove the Chain Ski

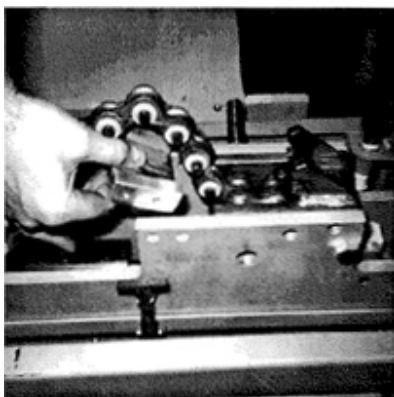

Remove the chain ski.

## Replacing the Cutting Chain (Continued)

### Lift the Cutting Chain Above the Snapping Mechanism Side Plates

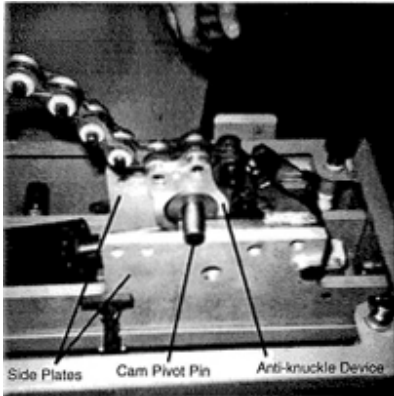

Grasp the cutting chain and pull upward to lift the anti-knuckle device and other attached items from between the side plates of the snapping mechanism. Lift high enough for the pivot hole of the cam to clear the top of the snapping mechanism side plates. Reinsert the cam pivot pin into this hole allowing each end of the pin to rest on the top of the snapping mechanism side plates.

### Loosen Shaft Collars on Each Side of Cam



With the cutting chain supported in a position above the snapping mechanism by the arrangement described above, loosen the set screws in the shaft collars on each side of the cam.

### Free the Cutting Chain



Using the 1/4" rod described earlier, push the chain retaining pin out to free the cutting chain from the cam. Pull the anti-knuckle device away from the cutting chain link pins.



## Replacing the Cutting Chain (Continued)

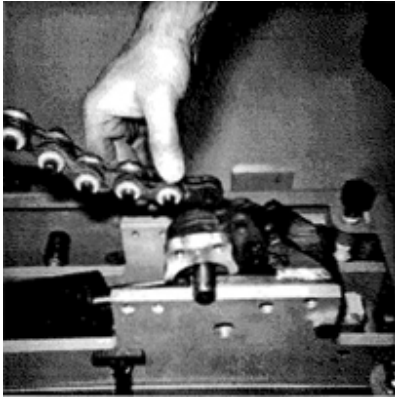

The cutting chain can now be removed for inspection and/or replacement.

### Remove the Cutting Chain

While the cutting chain is removed from the machine, take this opportunity to inspect the anti-knuckle device and the cam pivot pin for excessive wear. Replace these items as necessary.

### Inspect Assembly Components

To reinstall the cutting chain, follow the steps of this section in reverse.

### Reassemble

## Checking and Adding Hydraulic Fluid

### Check Oil Level



Open the side door by inserting a 5/16" Allen wrench in the door latch and turning it 1/4 turn counter-clockwise. Swing the door open.

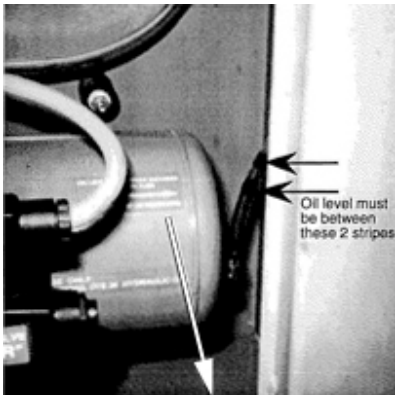

Locate the tube coming out of the bottom right hand side of the hydraulic pump reservoir.

The oil level must be between the stripes on the tube (or 1" from the top of the reservoir).

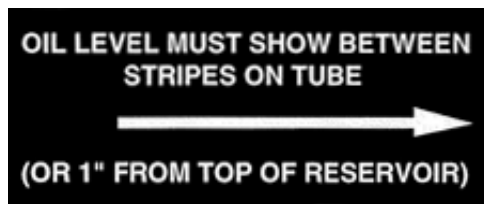

(Placard shown at actual size.)

See Placard Located on Side of Hydraulic Pump Reservoir

## Checking and Adding Hydraulic Fluid (Continued)

### Adding Oil

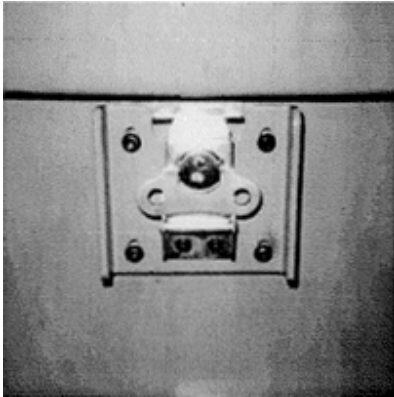

Unlatch the cam latch at the front of the machine and pivot the top open.

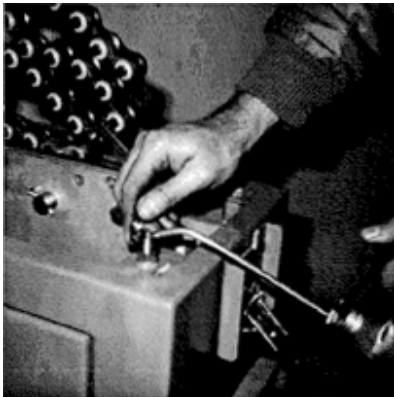

Locate the port labeled, "HYDRAULIC OIL FILL PORT" on the left hand side while facing the front of the machine. (See copy of placard below.)

Open the spring cap. Add oil slowly as it takes time for the oil to flow down the tube. We suggest the use of a pump type oil can to accomplish this task.

Use only Mobil DTE 26 Hydraulic Oil.

**HYDRAULIC OIL  
FILL PORT**

**USE ONLY:  
MOBIL DTE 26 HYDRAULIC OIL.**

(Placards shown at actual size.)

**Be Sure to Pay  
Attention to Placards**

## Transporting

The Kwik Snap 2500 is shipped from the manufacturer on a wooden pallet. It is recommended that the machine be palletized or crated when shipping by common carrier or over extended distances.

For ease of local transport, the Kwik Snap 2500 can be pivoted back from the wheels and transported in a reclined position. This allows the machine to be supported by the wheels and the handle.

This machine must only be transported in the upright position or in the reclined position. It is only to be tipped as illustrated below. Tipping the Kwik Snap 2500 more than 45° in any other direction will result in the release of hydraulic fluid.

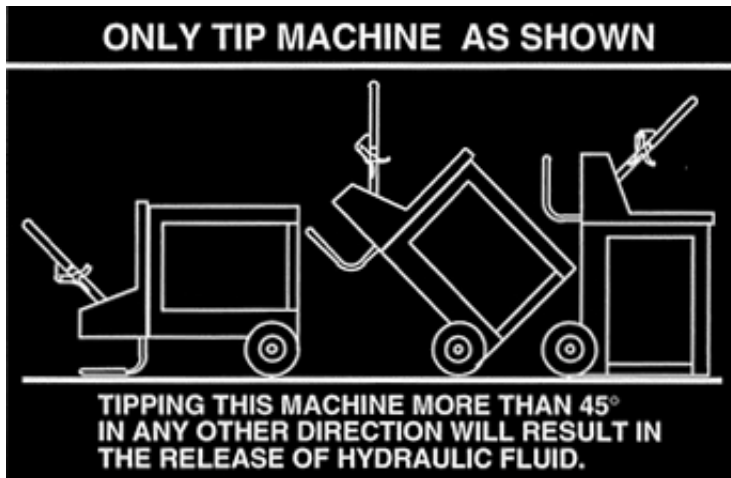

(Placard is reduced from actual size.)

**Operate the Kwik Snap 2500 in the upright position only.**

**Never attempt to tow your machine. The wheels are for handtrucking purposes only.**

**Palletize or Crate the  
Kwik Snap 2500 When  
Shipping**

**The Kwik Snap 2500  
May be Transported in  
Reclined Position**

### CAUTION

**See Placard on Back  
of Machine**

### NOTICE

## Trouble Shooting Guide

PROBLEM	POSSIBLE CAUSE	SUGGESTED REMEDY
Hydraulic pump motor does not run.	<ol style="list-style-type: none"> <li>1. No power to plug.</li> <li>2. Motor starter has tripped.</li> <li>3. Internal malfunction of motor.</li> <li>4. Malfunction of wiring between switch and motor.</li> </ol>	<ol style="list-style-type: none"> <li>1. Check power cord and source.</li> <li>2. Push motor control switch all the way off, then back on.</li> <li>3. Repair or replace hydraulic pump motor as required.</li> <li>4. Check wiring and repair or replace as required.</li> </ol>
Cutting chain retracts when unit is switched on.	<ol style="list-style-type: none"> <li>1. Malfunction of limit switch in overarm.</li> <li>2. Malfunction of relay.</li> <li>3. Malfunction of spool in hydraulic valve.</li> </ol>	<ol style="list-style-type: none"> <li>1. Check adjustment, then repair or replace limit switch as required.</li> <li>2. Repair or replace relay.</li> <li>3. Repair or replace hydraulic valve.</li> </ol>
Cutting chain extends when unit is switched on.	<ol style="list-style-type: none"> <li>1. Malfunction of limit switch in snapper unit.</li> <li>2. Malfunction of relay.</li> <li>3. Malfunction of spool in hydraulic valve.</li> </ol>	<ol style="list-style-type: none"> <li>1. Adjust cutting chain, then repair or replace limit switch as required.</li> <li>2. Repair or replace relay.</li> <li>3. Repair or replace hydraulic valve.</li> </ol>
Pipe is cut, but edge of cut is jagged.	<ol style="list-style-type: none"> <li>1. Cutting wheels are dull and/or chipped.</li> <li>2. Pipe is cracked or of poor quality.</li> </ol>	<ol style="list-style-type: none"> <li>1. Replace wheels and/or cutting chain as required.</li> <li>2. Verify pipe quality and inspect for cracks. Check with pipe supplier regarding product quality issues.</li> </ol>

## Trouble Shooting Guide (Continued)

PROBLEM	POSSIBLE CAUSE	SUGGESTED REMEDY
Oil leaks from machine.	<ol style="list-style-type: none"> <li>1. Machine has been tipped over improperly. (See transporting instruction.)</li> <li>2. O-rings between 4-way valve and pump head have failed.</li> </ol>	<ol style="list-style-type: none"> <li>1. Put machine in upright position and check for proper oil level.</li> <li>2. Replace o-rings with 90 durameter (hardness) o-rings (available from manufacturer).</li> </ol>
Cutting chain retracts and hydraulic pump motor stalls yet chain does not tighten.	<ol style="list-style-type: none"> <li>1. Cutting chain is not anchored on proper pin.</li> </ol>	<ol style="list-style-type: none"> <li>1. Reposition cutting chain so that proper pin is hooked in chain cleat.</li> </ol>
Cutting chain retracts and seems to get tight, yet hydraulic pump motor continues to run.	<ol style="list-style-type: none"> <li>1. Hydraulic oil level in reservoir is low and pump is cavitating.</li> <li>2. Key on motor shaft has sheared off.</li> </ol>	<ol style="list-style-type: none"> <li>1. Fill oil reservoir with Mobil DTE 26 Hydraulic Oil.</li> <li>2. Replace key on motor shaft.</li> </ol>
Cutting chain retracts and hydraulic pump motor stalls with chain tight.	<ol style="list-style-type: none"> <li>1. Inadequate hydraulic pressure.</li> <li>2. Cutting edges of cutting wheel are not sharp.</li> </ol>	<ol style="list-style-type: none"> <li>1. Shorten length of power cord to reduce electrical power drop to motor.</li> <li>2. Possible internal hydraulic leak. Refer to manufacturer.</li> <li>3. Replace cutting wheels and/or cutting chain as required.</li> </ol>

## Replacement Parts List

The following parts are the ones which most commonly wear with use. Occasional replacement will be necessary.

DESCRIPTION	QTY/ASSY	PART NO.
Complete Cutting Chain Assembly	1	3322-SM-14.5
Hold Down "Vee"	4	3322-OA-38.0
Anti-projection Pad	2	3322-TP-12.5
Cutting Chain Spring	2	3322-SM-13.0
Cutting Chain Spring Retainer	36	3322-SM-15.0
Cutting Chain Cleat Assembly	1	3322-SM-1.5
Safety Shield	1	3322-OA-1.5
Actuating Arm Return Spring	1	3322-OA-3.0

A comprehensive parts list is available from the manufacturer.

## Warranty

The Kwik Snap 2500 is warranted against defects in material and workmanship. This warranty covers replacement or repair of defective parts for a period of a year (excluding hydraulic pump motor and electrical parts, which are warranted for a period of 90 days from the date of sale). This warranty DOES NOT apply to units or component parts damaged or broken through abuse, overload or accident. Any alterations which affect the operation or condition of the unit, will void this warranty. Virtually all moving parts, including hydraulic hoses, can be expected to wear with time and/or use. Such normal wear and tear is not warranted.

**NOTICE:** Dull, flat excessively worn cutting chains must be replaced or repaired prior to use. Continued use of a dull cutting chain will place undue strain on virtually all mechanical parts and **WILL THEREFORE VOID WARRANTY.**

**NO OTHER WARRANTY, EITHER WRITTEN OR ORAL, SHALL APPLY.**

Products must be returned, freight prepaid, to HARRISON INDUSTRIAL SERVICES, INC. (HISI). If the warranty applies, the product will be repaired or replaced at no charge to the customer and returned freight prepaid. Only HISI can make warranty judgments and retains the right to the final decision regarding warranty applications. **THIS WARRANTY IS IN LIEU OF ALL OTHER WARRANTIES EXPRESSED OR IMPLIED, INCLUDING THOSE OF MERCHANTABILITY AND FITNESS. IN NO EVENT DOES MHC CORP.'S LIABILITY EXTEND BEYOND REPAIR OR REPLACEMENT OF ITS PRODUCT AS WARRANTED ABOVE.**



## Distributor & Manufacturer Information

### Distributor

Manufacturer's Representative  
PipeMan Products, Inc.  
Web Site: [pipemanproducts.com](http://pipemanproducts.com)  
1-877-PIPEMAN (747-3626)

Web Link: <https://pipemanproducts.com/products.php?cat=Kwik-Snap-2500-Production-Pipe-Cutter>

### Manufacturer

The Kwik Snap 2500 is manufactured by:

Harrison Industrial Services, Inc.  
3377 Deer Valley Rd., #163  
Antioch, CA 94531

Phone: 1-888-212-6095  
Fax: 1-888-212-6095  
Email: [info@harrison-isi.com](mailto:info@harrison-isi.com)  
Web: <http://www.harrison-isi.com>

### Identification Sticker

When requesting information or parts for your Kwik Snap 2500, please reference the serial number shown on the identification sticker located on the inside of the door of the machine.

